

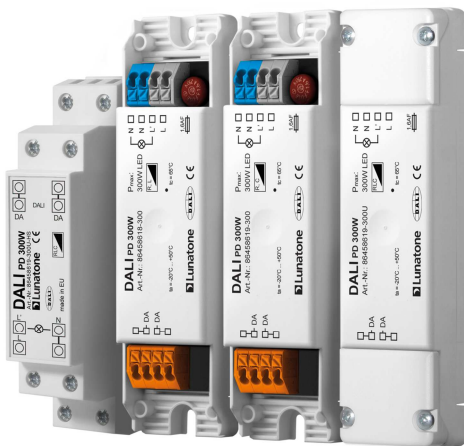

## DALI PD

## Datasheet

### Phase Dimmer Module



Phase Dimmer with  
DALI control input (DT4)

DALI PD:

Art. Nr. 86458618 (RL)

Art. Nr. 86458619 (RC)

Art. Nr. 86458619-25U (RLC)

DALI PD300:

Art. Nr. 86458618-300 (RL)

Art. Nr. 86458619-300 (RC)

Art. Nr. 86458619-300U (RLC)

Art.Nr. 86458619-300U-HS (RLC HS)

# DALI PD Phase Dimmer Module

## Overview

- Dimming of 230V LED-Retrofit-bulbs via DALI (Device Type 4 from firmware 3.0 and higher)
- Different types for loads from 3W to 25W (PD) for back box installation and for 10-300W (PD300) for remote ceiling and din rail
- trailing edge phase cut dimmer for resistive and capacitive loads, leading edge phase cut dimmer for resistive and inductive loads as well available as universal dimmer
- Conversion of the DALI dimlevel into a phase cut controlled voltage (trailing/leading edge)
- The minimum dim level can be set via DALI (MIN LEVEL)
- Additional operating mode as switch (DT7 compliant) available with firmware 3.5 and higher
- The module represents a DALI-line client and therefore it has its own DALI-address.
- Double DALI terminals - the DALI signal line is connected through.

## Specification, Characteristics

type	DALI PD		DALI PD 300W	
article number	86458618-25 (RL) 86458619-25 (RC) 86458619-25U (RLC)	86458618-300 (RL) 86458619-300 (RC) 86458619-300U(RLC)	86458619-300U-HS (RLC)	

### electrical data:

supply	via DALI-line		
typ. current consumption	6mA		
input	DALI		
DALI addresses	1		
mains voltage	230Vac		
trailing/leading edge phase angle	0°-180°		
load range	3W-25W	10W-300W	
max. output current	0,2Aeff ac	1,45Aeff ac	

### technical data:

dimensions (lxwxh in mm)	59x33x15	120x30x20	98x18x56
mounting	back box	remote ceiling	dinrail
ambient temperature	0°C to 50°C	-20°C to +50°C	
connection wire cross section	0,5-1,5 mm <sup>2</sup>	1,5-2,5 mm <sup>2</sup>	
protection class	IP20		

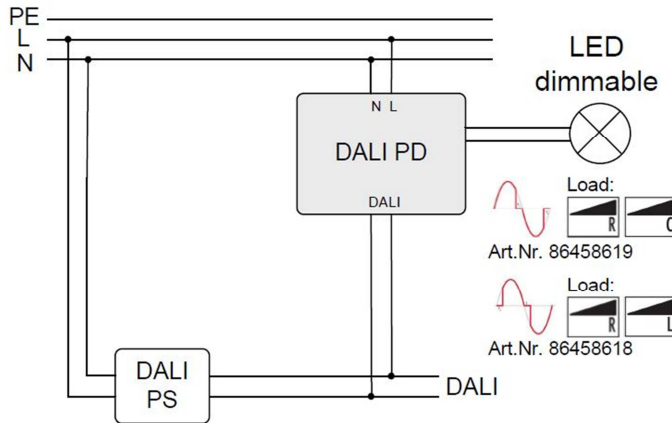

**ATTENTION:**  
Do not apply any potential to the light bulb connector!  
  
Switch off mains supply before replacing the light bulb.

typical structure

**Leading edge phase cut dimmer (Art.Nr. 86458618):**

dimmer type	suitable loads	note
		Not suitable for capacitive loads!

**Trailing edge phase cut dimmer (Art.Nr. 86458619):**

dimmer type	suitable loads	note
		Not suitable for inductive loads!

**Universal dimmer (Art.Nr 86458619-xxxU):**

dimmer type	suitable loads

**type of dimmers:**

- Leading edge
- Trailing edge
- Universal

**load:**

- 3-25W: compact housing for back box installation
- 10-300W: remote ceiling, din rail

When connecting multiple bulbs the same load type has to be used (inductive or capacitive).

**info universal dimmer:**

suitable for resistive, inductive and capacitive loads.  
After mains voltage is supplied the dimmer will recognize the load type and make a decision for leading edge phase cut operation (inductive load) or trailing edge phase cut operation (capacitive load)

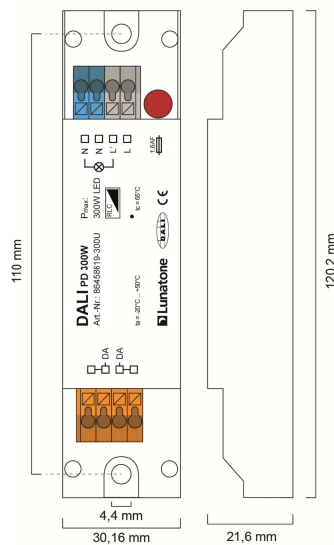

Dimensions PD300 DE

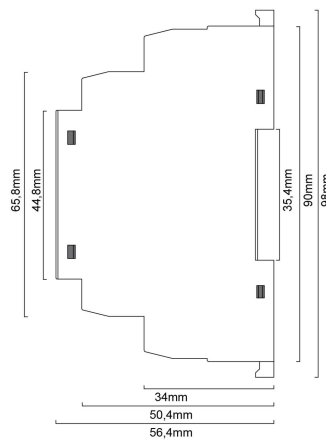

dimensions PD300 HS

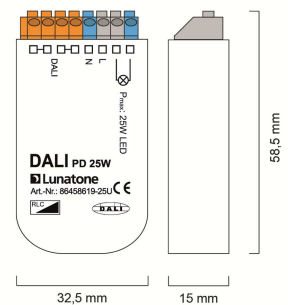

dimension PD



connection plan PD300 DE

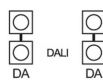

connection plan PD300 HS

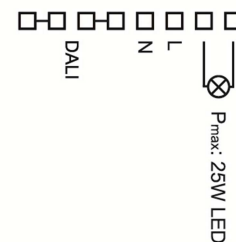

connection plan PD

## Connection

The DALI PD is connected to the DALI-line. The phase cut control and the DALI-communication is supplied directly by the DALI line. A typical value of the current consumption is 6mA. In order to supply components on a DALI line the installation of a power supply (DALI PS) is required. The connection to the DALI-line is polarity free. Internally the DALI-terminals are connected through as visualized on the housing.

The input of the phase dimmer (L-N) has to be connected to the mains. The DALI PD is suitable for loads from 3W to 25W or 10W-300W depending on the version.

The maximum output current of the dimmer must not be exceeded! Check the power factor of the bulbs in manufacturer's specification (especially when using lamps with power of 25W and below).

## Function

The DALI PD interface converts the DALI dim level into a voltage signal. The phase cut control generates a sinusoidal voltage with leading/trailing edge phase cut (logarithmic dimming characteristic corresponding to DALI). The operation mode (trailing/leading edge) can be queried via DALI (DT4). The PHYSICAL MINLEVEL is 3%.

Up from firmware version 3.5 an additional operating mode is supported. Instead of phase dimming (DT4) the device can act as switch (DT7 capable). Hence the switching characteristic is determined by the comparison of the virtual direct arc power level (VDAP) with 4 thresholds.

The virtual dim level (VDAP) is like the dim level of DALI-ballasts and is therefore limited by MINLEVEL and MAXLEVEL and influenced by fade-time and fade-rate.

For each dim direction 2 thresholds can be defined. They are compared with the virtual dim level and as a result the output is switched on or off:

virtual dim direction	comparison of virtual dim level and thresholds	output
UP	VDAP >= UP SwitchOn Threshold	ON
UP	VDAP >= UP SwitchOff Threshold	OFF
DOWN	VDAP <= DOWN SwitchOn Threshold	ON
DOWN	VDAP <= DOWN SwitchOff Threshold	OFF

If a threshold value is set to "MASK" the threshold is inactive and does not influence the relay output.

Find some examples of switching characteristics below:

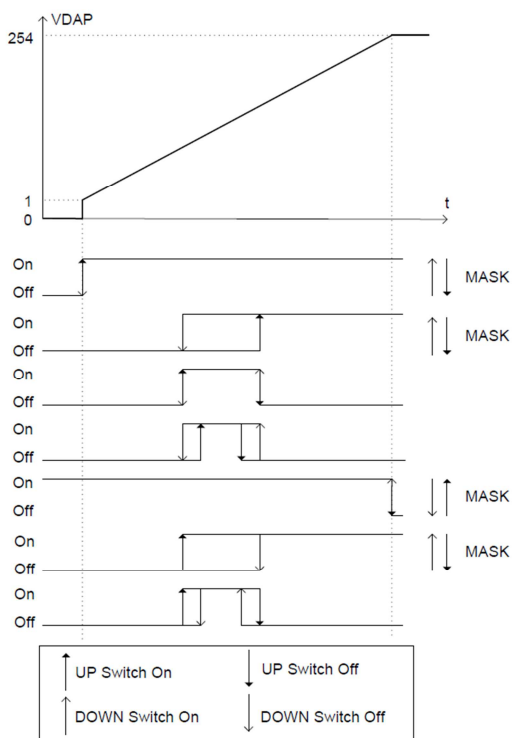

With the help of the fade time switch on and switch off delays can be realized.

Since the device is bus powered the configurable SYSTEM FAILURE LEVEL is not supported. In case of a DALI-line outage the DALI PD applies 100% at the output whereas at the output of the DALI PD300 0% are applied.

The Configuration can be done easily with the help of the DALI Cockpit:

General Settings:

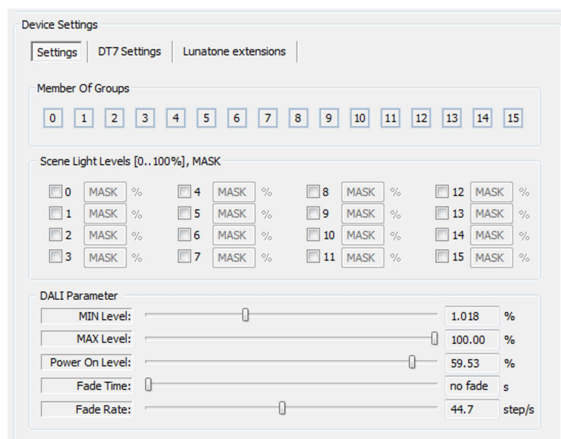

Lunatone Features:

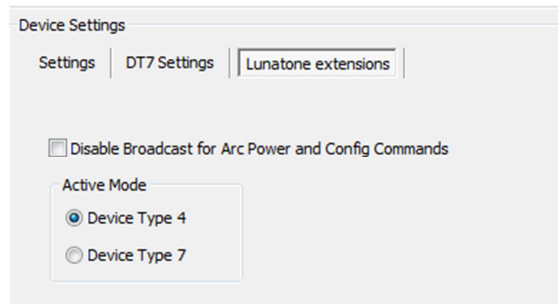

DT7 Settings:

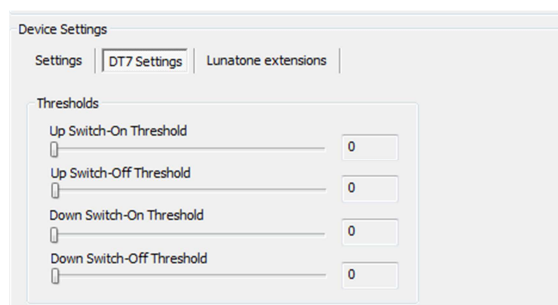

Purchase Order Information

article number: **864586xx – (extension)**

86458618-25: leading edge dimmer (RL), 3-25W, back box

86458618-300: leading edge dimmer (RL), 10-300W, remote ceiling, din rail type on request

86458619-25: trailing edge dimmer (RC), 3-25W, back box

86458619-300 trailing edge dimmer (RC), 10-300W, remote ceiling, din rail type on request

86458619-25U: universal dimmer (RLC), 3-25W, back box

86458619-300U: universal dimmer (RLC), 10-300W, remote ceiling

86458619-300U-HS: universal dimmer (RLC), 10-300W, din rail

## Additional Information and Equipment

DALI-Cockpit – free configuration tool from Lunatone for DALI systems

<http://lunatone.at/en/downloads/Lunatone-DALI-Cockpit.zip>

Lunatone DALI products

<http://www.lunatone.at/en/>

Lunatone datasheets and manuals

<http://lunatone.at/en/downloads/>

## Contact

Technical Support: [support@lunatone.com](mailto:support@lunatone.com)

Requests: [sales@lunatone.com](mailto:sales@lunatone.com)

[www.lunatone.com](http://www.lunatone.com)



## Disclaimer

Subject to change. Information provided without guarantee.  
The datasheet refers to the current delivery.

The compatibility with other devices must be tested in advance to the installation.